

Celebrating
Ten Years in Dallas



EXCELLENCE REDEFINED

OFFICIAL SHOW GUIDE



THE RITZ-CARLTON

SEPTEMBER 8 & 9, 2019
RITZ-CARLTON, DALLAS, TX

CALL 844-285-1103 TO REGISTER
OR VISIT WWW.SELECTJEWELRYSHOW.COM



COSTAR

FOR YOUR PRECIOUS MOMENTS...

Aria Collection



www.costarimports.com

Toll Free: 888.726.7827

Custom CAD Delivered in 2 Weeks!



Available on the
App Store

ANDROID APP ON
Google play

H. j. Namdar Diamonds





Fancies by AVA™

Fancy Shape Diamond Wedding and Eternity Bands
starting at 0.50ct up to 9ct

Authorize Retailer Program:

AVA CARE™ Lifetime Jewelry Care Plan
Alloy Program—Patent Pending
Nationally Advertised Brand
Marketing and Social Support
Eternity Band Resizing Service
Sales Incentive Program
Proudly Made in U.S.A.

STEVEN ROYCE



Certified Alexandrite

Pink Sapphire



Paraíba Tourmaline

Emerald



Sapphire

Tanzanite



Opal



Ruby



Diamond



Aquamarine

**BOOTH
18
(Dallas)**

BGK Graphics

516-466-0700

WWW.STEVENROYCE.COM EMAIL: INFO@STEVENROYCE.COM



JEWELERS FOR CHILDREN
A GIFT OF LOVE FOR CHILDREN IN NEED



Celebrating
Ten Years in Dallas



PLEASE JOIN US

Another great Select Jewelry show will take place at the elegant Ritz-Carlton in Dallas on September 8th and 9th. We would love to have you join us for this unique jewelry industry event. Come experience the Select Show difference and celebrate our 10th Anniversary in Dallas!

Every day of the show the wonderful staff at the Ritz will provide a continental breakfast to start and a scrumptious buffet lunch to follow. On Sunday evening don't miss the social mixer in Fearing's lounge from 6:30pm to 8:00pm.

We are pleased to be able to bring back Barbara Palumbo and Adornmentality, for her amazing insight on fine tuning your business. **See page 10** for details.

A signature of the Select show is the Buyers Raffle worth up to \$10,000!

The fun and exciting raffles are held on the show floor on Sunday and Monday afternoons. They're your chance to win the free money. You will have several different ways to earn tickets for chances to win. **See page 11.**

Please mark your calendar to be a part of this tremendous buying event.

September 8th - 9th, 2019 at the Ritz Carlton 2121 McKinney Ave, Dallas, Texas.

If you would like to pre-register please call 844-285-1103 or visit

www.SelectJewelryShow.com.

for more information.

The Select Team

SELECT JEWELRY SHOW

64 W 48th St, Suite 1005, New York, NY 10036

CALL 844-285-1103 TO REGISTER
OR VISIT WWW.SELECTJEWELRYSHOW.COM



Welcome

Come join your fellow
Texas Jewelers Association as we celebrate
Select's 10th Anniversary in Dallas.



TABLE OF CONTENTS

Welcome Letter.....	6
Exhibitor List.....	9
Schedule.....	10, 11
Raffle Details.....	11
Floor Plan	12, 13
Exhibitor Profiles.....	14

ADVERTISERS INDEX

Aiya Designs.....	16, 60
Ava Couture.....	4
Costar	2, 20, 52
DA Gold	22
Dinaro	24
Frederic Sage	26
Gem + Jewel.....	63
Gemoro	28
H. J. Namdar	3
Haridra by Hari Jewels.....	30
Imperial.....	33
Jewelers of America	61
John Atencio	37
Midas.....	43
Rembrandt Charms	48
Roman + Jules.....	50
Select Tucson.....	62
Steven Royce.....	5, 56
Texas Jewelers Association.....	7
Zeghani.....	59



THE RITZ-CARLTON

Dallas and the elegant Ritz-Carlton

2121 McKinney Ave,
Dallas, TX 75201

Phone: 844-285-1103

(Call for directions and other hotel information)

EXHIBITORS

Exhibitors as of July , 2019



A&D Gem/ Dvani.....	17	Lika Behar	29
ADA Jewelry LLC.....	201	Luca Lorenzini.....	35
Afarin	10	Marika Desert Gold	24
Aiya Designs.....	407	Mastoloni.....	27
Ara Collection.....	201A	Mazza Co.....	205
Artistry Ltd.	206	MCE.....	203
Asher	106	Meira T	301
Ashi.....	401	Midas Chain.....	34
Ava Couture.....	33	Natalie K.....	402
Color Jewels/ Cirari	306	Norman Covan	32
Costar	406	Officina Bernardi.....	101
DA Gold	104	Olivia B	202
Diabella	19	Paragon Couture	200
Dilamani	12	Picchiotti.....	102
Dinaro Creations.....	405	Qayten.....	103
Doves by Doron Paloma.....	11	Raymond Mazza	101A
Frederic Sage	16	Reko.....	403
Gemoro	30	Rembrandt Charms	22
Gordon & Co.....	Sp2	Roma Designs.....	304
Graymoor Lane Designs.....	206	Roman + Jules by First Image Design	100
Haridra by Hari Jewels.....	23	Royal Chain.....	20
Heera Moti	204	Royal Jewelry.....	31
Henderson	15	Royal Pearl.....	21
HJ Namdar	400	Samuel B	302
House of Baguettes.....	25	Shefi Diamonds	105
Imperial.....	300	Sophia by Design	303
Jewels by Jacob	26	Steven Royce	18
John Atencio	28	Vivid.....	305
Kabana	404	William Levine	21
KC Designs.....	307	Zeghani.....	Cedar
KGM	35		
Leslie Brand by Quality Gold.....	13		

SCHEDULE DAY 1

Sunday, September 8, 2019

8:30 – 9:45am Continental Breakfast served in **Maple Room**.

9:00 – 9:45am Sunday Morning Education:

How to Grow a Realistic Instagram Following for Your Business

Instagram's user count is expected to surpass Facebook's by the end of 2020, but your follower numbers seem to be stuck in the hundreds. Writer, podcaster, and industry veteran Barbara Palumbo will talk you through how to grow an organic following for your business and explain why working with micro-influencers are an affordable way to build your brand's awareness.



Barbara Palumbo

10:00am – 5:00pm Show Floor Open

12:30pm – 2:00pm Lunch served in **The Ballroom Foyer**

3:00pm – Raffle Drawing for at show purchasing credits worth \$ thousands. Collect raffle tickets based on purchases until 2:30pm, drawing at 4:00pm. You must be present to win.



6:30 – 8:00pm **Cocktail Party**. Enjoy cocktails and hors d'oeuvres with your Select Show friends at **Fearing's**.

Sponsored by-

Your
Vendors



THE
RETAIL JEWELER



SCHEDULE DAY 2



Monday, September 9, 2019

8:30 – 9:45am Continental Breakfast served in **Maple Room**

9:00 – 9:45am Monday Morning Brainstorming: **A Rising Tide Lifts All Boats**

The Jewelry Business – competitors or not we're all in it together. Join this moderated session to discuss the challenges and opportunities the future holds. Brainstorm new ideas and learn from each other.

10:00am – 4:00pm Show Floor Open

12:30pm – 2:00pm Lunch served in **The Ballroom Foyer**

3:00pm – Raffle Drawing for at show purchasing credits worth \$ thousands. Collect raffle tickets based on purchases until 2:30pm, drawing at 3:00pm. You must be present to win.



RAFFLE DETAILS!

Remember to participate in our 2019 Buyer Raffle worth up to \$10,000 in At-Show Purchasing Credits.

Be sure to get a copy of Every Purchase Order you place at the show to get more raffle tickets.

The Following are Aggregate Purchase Dollar Incentives:

If you write and present \$5,000 or over in collective Purchase Orders at the show, you get one additional raffle ticket;

\$10,000 or over gets you 2 more extra raffle tickets;

\$15,000 or over, 3 more extra raffle tickets;

\$20,000 or over, 4 more extra raffle tickets;

\$25,000 or over, 5 more extra raffle tickets;

\$35,000 or over, 7 more extra raffle tickets;

\$50,000 or over, 10 more extra raffle tickets;

\$100,000 or over, 20 more extra raffle tickets.

• **Remember, you must be present to win, but if you have a non-winning tickets on one Sunday, they will be included again in the Monday drawing.**

FLOOR PLAN

September 8 & 9, 2019
Ritz-Carlton, Dallas, TX

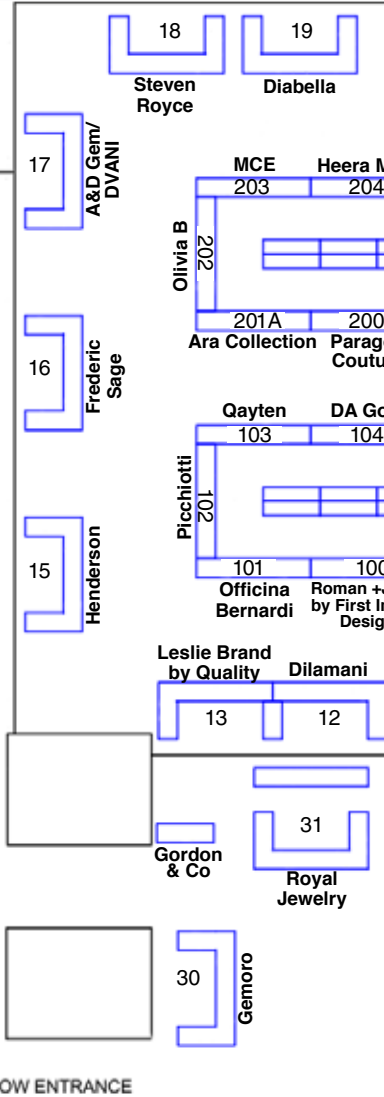
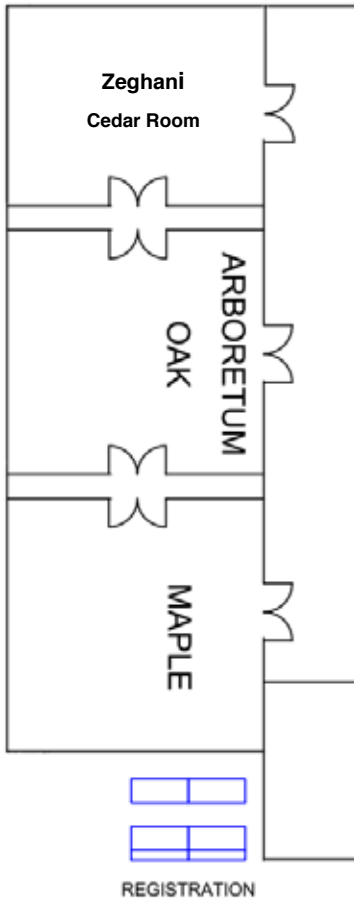

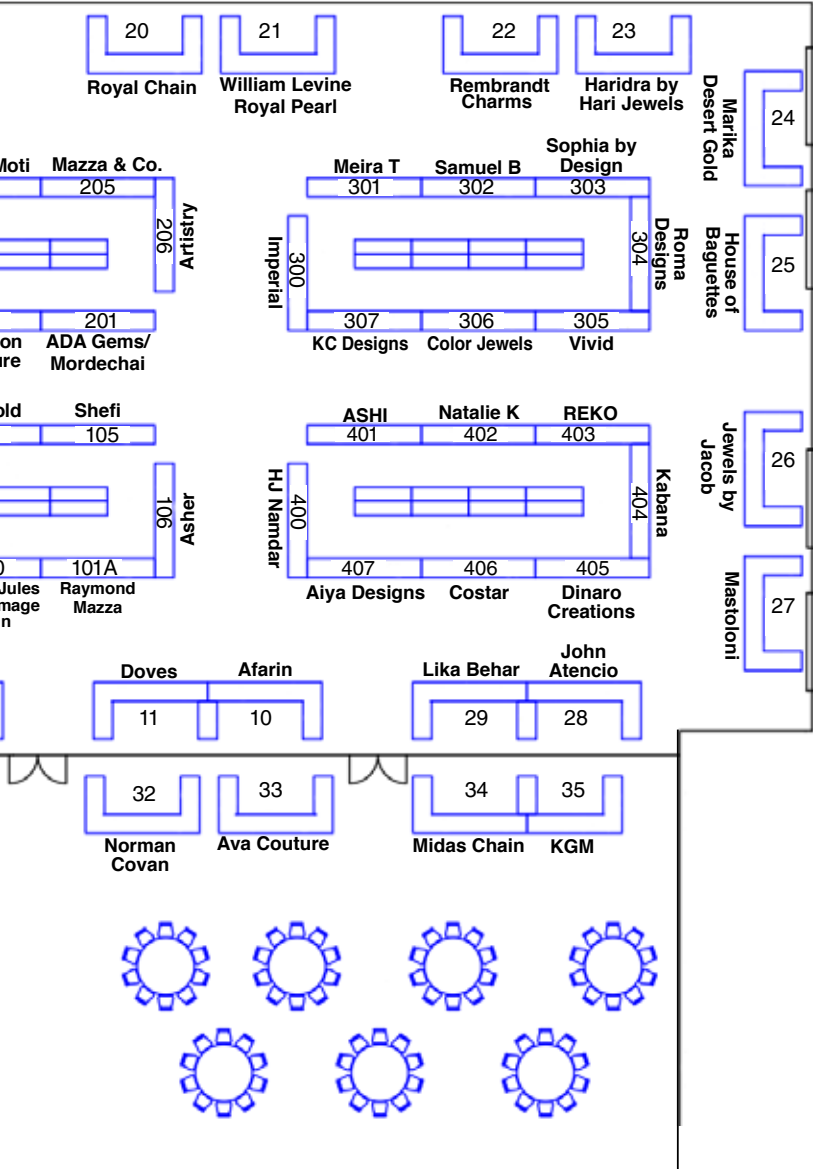

EXHIBITORS

A&D Gem/DVANI



Booth 17

98 Cuttermill Rd Ste 207N
Great Neck, NY 11021
212-944-2700
www.dvanijewelry.com

Dvani provides women fashion-forward ability to accessorize with genuine gemstone and precious jewelry at accessible price points.

Jason Kordvani
jason@jewelsbyad.com

D V A N I
by **A&D Gem Corp.**

ADA Jewelry LLC



Booth 201

50 West 47th St. #1717
New York, NY 10036
212-719-0190 Fax: 212-719-0692
www.mordechaicollection.com

Diamond importer and jewelry manufacturers for over 28 years. Servicing the USA, US Virgin Islands, Canada and Southeast Asia. Diamond bracelets, necklaces, hoops and emerald cut bands. Additionally we have just launched our Italian hand-made jewelry.

Daniel Mordechai
adagemsny@aol.com



Afarin

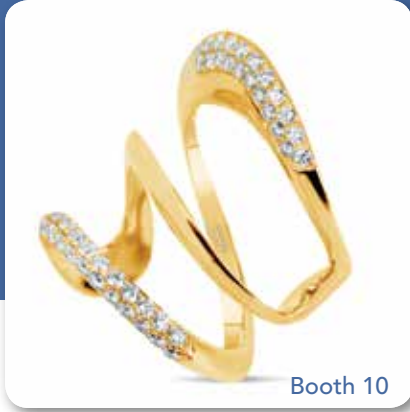

Booth 10

98 Cuttermill Rd., Ste. 410
Great Neck, NY 11021
212-944-0188 Fax: 212-944-2774
www.apafarin.com

Afarin is a direct manufacturer of exquisite luxury jewelry at affordable pricing while implementing superior craftsmanship in every design.

Jason Hakimi
jason@apafarin.com



Aiya Designs



Booth 407

152 Prospect Pl
Alpharetta, GA 30005
770-664-1818 Fax: 770-740-9529
www.aiyadesigns.com

Aiya Designs is a fourth-generation manufacturer and quality is our signature. We have guaranteed sales programs in diamond fashion, Italian gold and silver, lab created stones, or LED lights. We offer dollar for dollar stock balance across it all. Check us out on www.Aiyadesigns.com, piyaro.com, lustour.com, jewelryled.com.

Sunny Aiya
shows@aiyadesigns.com



Select Dallas
Booth #407

PiYaRo

By Aiya Designs



*Quality is our
Signature*

*Sterling with Solid 14K Gold
H - VS Diamonds*



*Hold & Behold
Excellence*

Dollar for Dollar Stock Balancing Across All Our Lines

www.PiYaRo.com

sales@AiyaDesigns.com | 888-427-8886

Hot New Rage! Salt & Pepper Diamonds & Slices



Select Dallas
Booth #407

*Call About Our One
of a Kind Salt & Pepper
Loose Diamonds*



AIYA DESIGNS

888-427-8886

www.AiyaDesigns.com



Dollar for Dollar Stock Balancing Across All Our Lines

EXHIBITORS



ARA Collection



Booth 201A

1253 Coast Village Rd
Santa Barbara, CA 93108
Mobile: 805-680-5757
Office: 805-965-3999

ARA Collection is known worldwide for handcrafted 24K gold jewelry. Each piece is created in Turkey, with careful attention to quality and workmanship. Inspired by the rich history of Ancient Anatolia and the Mediterranean Sea.

Cuneyt Akdolu
aracollectionusa@gmail.com



Artistry Ltd.

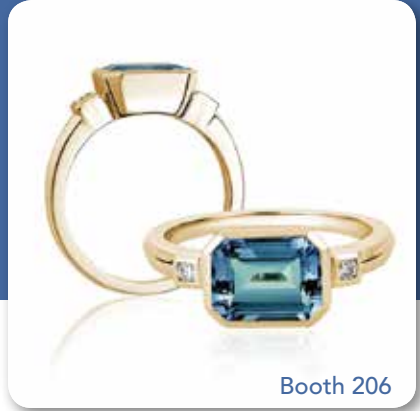

Booth 206

8272 Lincoln Ave.
Skokie, IL 60077
847-674-3250 Fax: 847-674-3208
www.artistrylimited.com

Artistry, Ltd. offers refined interpretations of the latest trends and classics. Our Collections are beautifully-crafted in diamond, color, gold and sterling silver. With accessible price points, excellent profit potential and same-day shipping, Artistry offers a steady stream of outstanding designs of exceptional quality, without compromise.

Susan Klemt Williams
susan@artistrylimited.com



EXHIBITORS

Asher Jewelry



Booth 106

175 Great Neck Rd., Ste. 201
Great Neck, NY 11021
212-302-6233 x 202
www.asherjewelry.com

For over 35 years, Asher has been a leading manufacturer of Designer Jewelry for independent retailers on a global level. Specializing in the latest jewelry trends, Asher features the most complete collection of the hottest styles without the inflated pricing throughout the jewelry industry.

Fred Asher
Fred@asherjewelry.com

Asher

Ashi



Booth 401

18 E. 48th St., 14th Floor
New York, NY 10017
212-319-8291 Fax: 212-319-4341
www.ashidiamonds.com

Now celebrating 35 years, Ashi has partnered with the finest independent jewelers throughout North America. We provide a wide array of services to help them better serve their own clients. Ashi is proud to present our latest artistic venture, Couture by Ashil. This collection will delight your clients and help celebrate life's most precious moments.

Terry Adair
terryadair@ashidiamonds.com

Neal Bass
nealbass@ashidiamonds.com

ASHI

Ava Couture

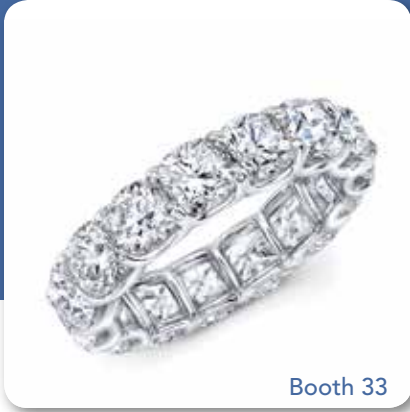

Booth 33

2300 Lakeview Parkway Ste 700
Alpharetta, GA 30009
404-551-3259

Ava Couture specializes in fancy shape diamonds, eternity bands, and wedding bands. We offer an eternity band alloy program, brand displays, AVA CARE Lifetime Care Plan, Eternity Resizing Service and a comprehensive digital media marketing plan.

Jeetu Bhagwanji
sales@avacouture.com



Cirari / Color Jewels

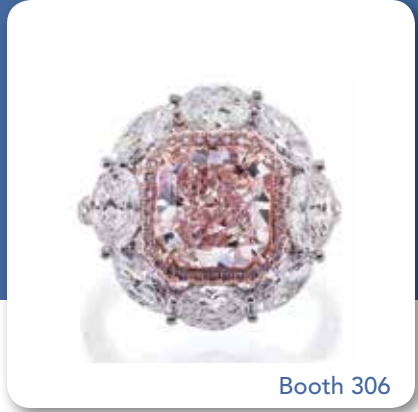

Booth 306

36 W. 44th St Ste 900
New York, NY 10036
212-764-2823
www.Cirari.com

Cirari is a leading designer and manufacturer in the gemstone and diamond jewelry industry, offering precious and semi-precious stones in a variety of different cuts and designs. Our collection is finely crafted with exquisite style and competitive prices to meet every woman's demand.

Tarek Elshaarawi
Tarek@colorjewels.net





COSTAR

FOR YOUR PRECIOUS MOMENTS...



www.costarimports.com

Toll Free: 888.726.7827

Custom CAD Delivered in 2 Weeks!

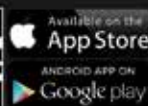

EXHIBITORS



Costar Imports



Booth 406

800 Airport Boulevard, Ste. 304
Burlingame, CA 94010
650-389-6969 Fax: 888-726-7827
www.costarimports.com

Costar Imports has been serving Fine Jewelry Independents in the United States since 1988. Combining decades of wholesale diamond experience with talented designers and expert manufacturing specialists, we bring the latest in bridal and fashion diamond jewelry.

Avinash Bajaj
info@costarimports.com

DA Gold



Booth 104

2 West 46th St.
New York, NY 10036
212-819-1111 Fax: 212-730-5706
www.dagoldproducts.com

DA Gold offers exquisite, elegant and Fashion forward designs created in Italy. Commitment to our customers and attention given to each finished piece sets us apart. Come and see for yourself.

Felix Vickers

Snezana Otonoga
da@dagoldproducts.com





EXHIBITORS



Diabella



Booth 19

98 Cuttermill Rd., Ste 295N
Great Neck, NY 11021
516-773-3636 Fax: 516-773-3637
www.diabellajewelry.com

Specializing in High Fashion, Classics, Bridal, and Wedding bands. Manufacturing in 14K, 18K, and, platinum and SI1 GH color diamond quality.

Isaak Nassimi
isaak@diabellajewelry.com

Dilamani



Booth 12

98 Cuttermill Rd., Ste 262
Great Neck, NY 11021
516-466-6767 Fax: 516-466-7906
www.Dilamani.com

When three decades of jewelry expertise meets design innovation unlike any other, you have Dilamani. A brand of exquisite jewelry that grows with you - always fresh, always evolving. Our desire is to help you build customer relationships through our beautiful pieces.

William Dilamani
info@dilamani.com

DIABELLA



Flexible Bangles



Emette
Collection



Here's What's Hot!



The Expandable™ Collection
Jewelry that flexes & expands.

Please visit us at
Select Dallas & Foxwoods

 **DINARO** Creations

98 Cuttermill Road, Suite 396N, Great Neck, NY 11021

Tel: 516-439-5200 • Fax: 516-439-5206

www.dinarocreations.com • dinarocreations@gmail.com

EXHIBITORS



Dinaro Creations



Booth 405

98 Cuttermill Rd., Ste. 396N
Great Neck, NY 11021
516-439-5200 Fax: 516-439-5206
www.dinarocreations.com

Dinaro Creations is a manufacturer of fine 14K and 18K Diamond Jewelry. They offer very competitive pricing and nice stock balancing programs. The above piece is part of their Bolo expandable bracelet collection. Starting price points are \$249.

Behnaz Ebrani
dinaro26@aol.com

Doves by Doron Paloma



Booth 11

98 Cuttermill Rd., Ste. 493
Great Neck, NY 11021
516-509-1346 Fax: 518-504-1348
www.dovesjewelry.com

Designed as a harmony of nature and art, Doves by Doron Paloma uses natural gemstones set in 18K gold, with exquisite diamond pave. Doron's journeys and architectural background inspire the color and styling of every work of art, including the art-deco inspired Gatsby collection. Doves continues to be a celebrity favorite on red carpets everywhere.

Doron Hakimian
Doron@dovesjewelry.com

 **DINARO** *Creations*

DOVES
DORON PALOMA

A portrait of a young woman with long, wavy brown hair and light-colored eyes. She is wearing a yellow top with a blue floral pattern, a delicate necklace with a small pendant, and a small earring. The background is a brick wall with green foliage. At the bottom center, there is a dark green rectangular box with a white border containing the text 'FREDERIC SAGE' in white serif font.

FREDERIC
SAGE

EXHIBITORS



Frederic Sage



Booth 16

98 Cuttermill Rd
Great Neck, NY 11021
516-482-1424
www.fredericsage.com

Frederic Sage "Better" Everyday Diamonds from the Firenze Collection is made with the finest diamonds and available in multiple gold tones. Starting MSRP \$995.

Frederic Sage
fred@fredericsage.com



Gemoro



Booth 30

98 Cuttermill Rd., Ste 466 S
Great Neck, NY 11021
212-768-8844
www.gemoro.com

World's largest selection of black and white diamond jewelry. Available in matched sets and price points, a collection of rose gold with brown diamond jewelry and our new Collection of Petite 18K white diamond jewelry.

Sales Team
sales@gemoro.com



WORLD'S LARGEST SELECTION
of Black Diamond Jewelry
starting from \$199



NEW PETITE 18
18K GOLD

SHOW SPECIALS

\$699

\$399

\$175

Dallas Show
Booth #30

gemoro®
www.gemoro.com
(212) 768-8844

EXHIBITORS



Gordon Company



Booth SP2

N. Federal Highway
Pompano Beach, FL 33062
954-763-9800
www.gordonco.com

The Gordon Company provides strategically designed owner transitions, cash raising events, store closings, and retirement sales for retail jewelers. Our "hands-on approach" means our key executives bring a lifetime of experience directly to your event. We provide on-site sales professionals, marketing, and media buying that will exceed your expectations. Ask for our Case Study Book to learn how we can serve you.

Jeff Gordon
info@gordonco.com



Graymoor Lane Designs



Booth 206

8272 Lincoln Avenue
Skokie, IL 60077
888-674-8340 Fax: 847-674-3208
www.graymoorlanedesigns.com

Graymoor Lane Designs brings Mid-Century style to the modern woman. Our stunning jewelry collections combine elegant 14K gold and delicate diamond pavé in wearable favorites that put a fresh twist on timeless design. Founded by women, inspired by women, GLn delivers a modern aesthetic rooted in an enduring design.

Susan Klemt Williams
susan@graymoorlanedesigns.com

Graymoor Lane™
DESIGNS

Haridra
NEW YORK
By Hari Jewels



EXHIBITORS



Haridra by Hari Jewels



Booth 23

62W 47th St. #503
New York, NY 10036
212-354-7550 Fax: 212-643-7570
www.haridrany.com

We at Haridra strive for perfection and innovation. Our high-end line of jewelry shows our keen interest in blending traditional and modern designs to create something new and unique. Visit us once to become spellbound and enjoy a piece of joy and celebration.

Atin Jain
info@haridrany.com



Heera Moti



Booth 204

15 W. 47th St Ste 808
New York, NY 10036
212-7641-600 Fax: 212-764-0007
www.heeramoti.com

Heera Moti is a premier diamond jewelry manufacturers servicing the finest independent retail jewelers in North America, South America and Canada. Our focus is to help you grow your business, maximize your sales and build your brand by providing unparalleled value and quality for an exceptional price since 1987

Heena Sadhwani
ishaan@hmijewelry.com



EXHIBITORS



Henderson Collection



Booth 15

2300 E 7th St. #201
Charlotte, NC 28204
800-605-3035 Fax: 704-333-3032
www.wlhlimited.com

18K Venetian and 18K/SS Firenze Enamel Collections are created using a unique enamel process that is a hybrid of the beautiful glass-based enamel and the more durable resin-based enamel. New styles include ombre enamel, swirl finishes and gem stone accents. All pieces are available in any finish and pantone color and have a lifetime guarantee. Nationally recognized Instore Event program along with an interactive website.

Ann Gieser
ann@thehendersoncollection.com



H.J. Namdar



Booth 400

16 West 46th St. 9FL
New York, NY 10036
212-398-9564 Fax: 212-575-1020
www.hjnamdar.com

For over three generations, H.J. Namdar has been known as the industry leader for fine jewelry. Our worldwide reputation for quality, value and integrity is unsurpassed. The H.J. Namdar inspirations emerge from many places, including nature, fashion and the core classic. All our designs have the wear ability to be "everyday" luxury and yet have the "red carpet allure". H.J. Namdar truly stands for luxury that is made affordable for the everyday customer.

Benny Namdar
benny@hjnamdar.com





IMPERIAL®

WE ARE PEARLS

WWW.IMPERIALPEARL.COM

EXHIBITORS

House of Baguettes



Booth 25

607 S Hill St #920
Los Angeles, CA 90014
213-627-2808 Fax: 213-627-0778
www.houseofbaguettes.com

Dealing with diamond jewelry for generations House of Baguettes marries beautiful designs with the finest diamonds. Our company brings a fresh and innovative approach to jewelry design acting as a liaison between the end user and retail store.

Our goal is to exceed the expectations of every client by offering outstanding customer service, increased flexibility, and greater value thus optimizing sales and inventory efficiency

Joseph Sengul
jsengul@aol.com

HOUSE
BAGUETTES

Imperial



Booth 300

795 Waterman Ave
East Providence, RI 02914
401-434-2597 Fax: 401-434-0814
www.imperialpearl.com

Imperial is an international pearl jewelry brand with a fierce passion for fine pearls and fresh, innovative design. Offering all varieties of pearl jewelry, strands, and programs coupled with branding, marketing and education. Imperial...we are pearls

Michael Tracy
michaeltracy45@gmail.com

Moe Richard
mjr826@comcast.net

IMPERIAL[®]
WE ARE PEARLS

Jewels by Jacob



Booth 26

15 West 47th St., Ste 603
New York, NY 10036
212-391-8700 Fax: 718-785-9797
www.jbjacob.com

Jewels by Jacob portrays a sense of beauty through its jewelry that you won't find anywhere else. Come and experience the extraordinary at Jewels by Jacob – your imagination will come to life.

Sammy Ghassabian
sammy@jbjacob.com



John Atencio

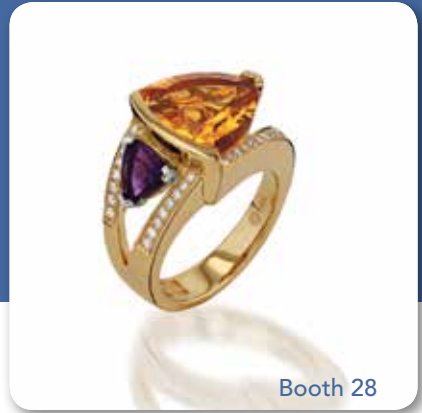

Booth 28

3000 E. 1st Ave. Ste 181
Denver, CO 80206
720-445-5292
www.JohnAtencio.com

John Atencio is an award winning jewelry designer and Colorado native. The John Atencio Collection reflects John's artistry, time-honored aesthetic and commitment to creativity. Each piece is hand sketched and finely crafted to realize John's vision. The collection includes gold fashion, sterling silver, men's, bridal, and one-of-a-kind pieces.

Lex Atencio
latencio@johnatencio.com

JOHN ATENCIO.

EXHIBITORS



Kabana



Booth 404

616 Indian School Rd NW
Albuquerque, NM 87102
505-843-9330 Fax: 505-843-9624
www.kabana.com

Founded in 1975 in Albuquerque, New Mexico, Kabana jewelry continues to lead the industry in quality and design. Kabana is one of very few fine jewelry designers and manufacturers that can claim its creations to be entirely made in the USA.

Cara Lawrence
cara@kabana.com

KABANA

EST^d. 1975
Handcrafted Fine Jewellery

KC Designs



Booth 307

64 West 48th St. Ste 1005
New York, NY 10036
212-921-9270
www.kcdesignsnyc.com •
socialmedia@kcdesignsnyc.com

KC Designs has become one of the leaders in fine fashion jewelry for over 30 years. Their commitment to producing "Everyday Diamonds" at affordable prices has earned them a reputation of excellence among major brand retailers and fashion authorities alike.

Tiffany Sabo
tiffany@kcdesignsnyc.com

KC DESIGNS

everyday diamonds

JOHN ATENCIO®



Please Visit Us At The Dallas Select Show: September 8-9.

3000 East First Avenue, Denver, Colorado 80206
720-445-5292 wholesale@johnatencio.com

EXHIBITORS

KGM Industries



62 West 47th St., #501
New York, NY 10036
212-944-7068
www.kgmind.com

KGM Industries INC. is a family owned fine jewelry manufacturer base in NYC since 1995. Our highest standards and competitive facilities create quality works of art!

Prices start at \$249 0.25ctw, \$599 1ctw.

Ken Ghaytanchi
kgmind@aol.com



Leslie's Brand Quality Gold



500 Quality Blvd.
Fairfield, OH 45014
800-354-9833 Fax: 800-962-4246
www.qgold.com

Wrap your wrist in luxury with a 14K yellow gold 20.4-gram Italian Panther Bracelet from Leslie's.

We offer stock balance for both gold and silver and lifetime guarantee on all gold product.

Leslie's Seasonal Dating Program has begun. Please stop by for details.

Pinny Rubin
pinny@qgold.com



Lika Behar Collection

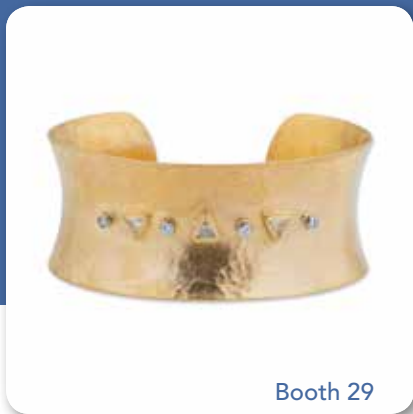

Booth 29

80 Triangle Blvd
 Carlstadt, NJ 07072
 201- 933-7200
www.likabehar.com

Lika Behar Collection cleverly combines ancient history with the sensibility of the modern world. Lika's creations bring an attainable New York City sophistication and elegance to an ancient craft.

Lika Behar
lika@likabehar.com



Luca by Lecil



Booth 15

2300 E 7th St. #201
 Charlotte, NC 28204
 800-605-3035 Fax: 704-333-3032
www.wlhlimited.com

Handmade Italian Fine Fashion Jewelry, Luca Lorenzini Featured by Lecil original designs represent a bold fusion of classic and modern Italian design. All natural elements; Sterling silver with 18K vermeil, hand crafted leather and diamond cut white sapphires. MSRP from \$100-\$990. Luca Couture MSRP up to \$1,795. All pieces come with a manufacturer's warranty.

Lecil Henderson
generalinfo@wlhlimited.com



EXHIBITORS

Marika Desert Gold Ltd



Booth 24

PO Box 12538
Hertzlia, Israel
216-759-7569
www.marikadesertgold.com

Marika Desert Gold intertwines nature into each piece highlighting organic color and natural shapes, which complement a women's body. "Marika" blends a mixture of ancient designs from Mediterranean and Middle Eastern goldsmithing cultures creating contemporary, beautiful jewelry inspired to be exotic and appealing to intelligent women with a spirit for adventure.

Paul Vopat
paul@mijbymarika.com

MARIKA
DESERT GOLD

Mastoloni



Booth 27

415 Madison Ave.
New York, NY 10017
212-757-7278 Fax: 212-582-0884
www.mastoloni.com

The Most Beautiful Pearls In The World™

Ray Mastoloni
raymond@mastoloni.com

MASTOLONI
The Most Beautiful Pearls In The World™

Mazza Co



Booth 205

2145 Marion Pl
Baldwin, NY 11510
516-379-4130 Fax: 516-379-4152
www.mazzajewelry.com

For almost two centuries, The Mazza Company has been offering color at it's best! William and his three sons carry on their proud heritage using hand-carved gemstones to create spectacular colored collections with 14K or 18K and diamonds.

William Mazza
billmazza@verizon.net

MCE Jewelry Corp

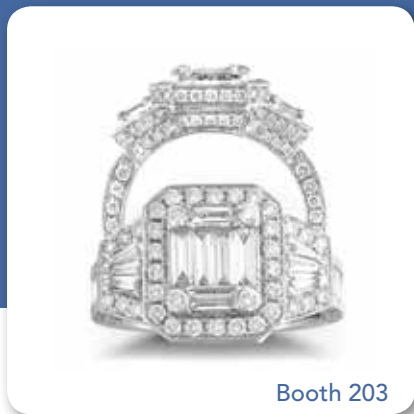

Booth 203

98 Cuttermill Rd Rm 297 N
Great Neck, NY 11021
516-864-3594

At MCE, We carry a full line of finished Jewelry in rings, earrings, pendants, bracelets, necklaces and much more. Come take a look at our extensive line of close outs in 10K, 14K, 18K, and see for yourself our amazing prices.

Mehran Enayatian
mcecorp@aol.com

MAZZA
THE MAZZA COMPANY

MCE
JEWELRY

EXHIBITORS



Meira T Designs



Booth 301

17 East 48th St., Rm. 401
New York, NY 10036
212-398-0726
www.meiratdesigns.com

Rainbow is the new black. These gorgeous Rainbow Sapphire earrings are surrounded by diamonds and set in yellow gold.

Meira Tugendhaft
Info@meiratdesigns.com

meiraT

Midas Chain



Booth 34

151 Veterans Drive
Northvale, NJ 07647
201-244-1150 Fax: 201-244-1151
www.midaschain.com

Jewelry manufacturer Midas Chain is approaching 40 years in business. The company prides itself on its 14 karat gold chain and fashion lines, as well as collections in 10 karat gold, 18 karat gold, and sterling silver. Midas jewelry continually evolves to new levels, while craftsmanship remains unparalleled in quality.

Mark Doris
mark@midaschain.com

MIDAS



MIDAS

Booth 34

midaschain.com | 201-244-1150

EXHIBITORS

Natalie K



Booth 402

606 S. Olive St. Ste 900
Los Angeles, CA 90014
213-629-0038 Fax: 213-629-5587
www.nataliek.com

M. K. Diamonds & Jewelry offers an extensive selection of 1ct center completes starting at \$1,995, Natalie K bridal, and Forevermark diamonds.

Gina Renteria
gina@mkdj.com

NATALIE K

Norman Covan



Booth 32

510 W 6th St , #202
Los Angeles, CA 90014
213-488-9144 Fax: 213-622-3959
www.normancovan.com

Norman Covan strives to bring stunning jewelry to the people who appreciate the artistry, quality and workmanship.

Ari Lokmagozyan
ari@normancovan.com

NORMAN COVAN

Officina Bernardi



Booth 101

390 5th Ave #705
 New York, NY 10018
 212-273-0797 Fax: 212-273-0870
www.officinabernardi.com

Made 100% in Italy, Officina Bernardi embodies the beauty of Italy, brimming with style and quality. We use the finest sterling silver and 18K gold and carve the surface using our patented moon cutting technique.

Katherine Whitacre
katherine@officinabernardi.com

Olivia B



Booth 202

20 Laurel Hill Terrace #6D
 New York, NY 10033
 917-736-0885
www.oliviabjewelry.com

Founded in 2016, Olivia B. is a 14K gold jewelry line defined by vibrant gemstones and accented with diamonds. With styling that is clean, fresh and sophisticated, Olivia B. is accessible luxury jewelry, wearable for day or evening.

Vibrant 14K earring and pendant set features amethyst and rhodolite briolettes, accented with bezel set diamonds. By Olivia B.

Shari Cuartero
shari@oliviabjewelry.com

EXHIBITORS

Paragon Couture Group



Booth 200

2 West 45th St Ste 608
New York, NY 10036
800-435-8848 Fax: 212-391-6712
www.paragoncouture.com

Paragon introduces the Equinox Gold Collection for Men, a trendsetting collection designed to reinforce a daring and unique statement. Our designs incorporate bold motifs that project masculinity and confidence. Proudly manufactured in the US.

Rodney Kamali
Rodney@paragoncouture.com



Picchiotti



Booth 102

Corso G. Garibaldi, 137
Valenza AL 15048 Italy
3.93358E+11 Fax: 3.90132E+11
www.picchiotti.it

Picchiotti is recognized as one of the world's leading jewelry manufacturers with timeless designs, heirlooms to be passed on to the next generation.

Maria Carola Picchiotti
mariacarola@picchiotti.it



Qayten



Booth 103

510 W 6th St Ste 416
Los Angeles, CA 90014
213-624-2277 Fax: 213-624-2278
www.qayten.net

Founded in 2010 in Bologna (Italy), Qayten is the house of the creativity where aesthetics, technical innovation and cutting-edge designs blend together while honoring the traditional techniques for an ever-wearable contemporary jewellery.

Maddalena Allegretti
maddalena@qayten.net

QAYTEN
• • •

Raymond Mazza



Booth 1001A

9 N Windsor Ave
Brightwaters, NY 11718
800-841-3460 Fax: 631-968-6561

The Raymond Mazza Company is a 21st century extension of an Italian jewelry tradition that began circa 1775. Come see our new hand crafted designs.

Raymond Mazza
loumaz6@aol.com



RAYMOND MAZZA JEWELRY

Rembrandt Charms®

Precious charms for precious memories.

Cultivate Generations of Loyal Customers with Rembrandt Charms!



Business Building Charm Program Benefits:

- Rembrandt's charm displays generate \$4,500 - \$7,500 in sales per square foot!
- Complete selection of inventory-controlled displays available. Re-order only what you sell!
- Our vertical displays contain the best-selling charms by region, leading to impulse Sterling Silver sales and Karat Gold special orders.
- Our charm collectors are loyal, repeat customers!
- Store Listing on our Website Retail Locator. Are you listed?



Digital and Print Marketing Support!



What Retailers Are Saying

"Rembrandt's Program has been a success for our stores for over 35 years! They provide us with an array of creative and timely marketing support for our digital and print advertising strategies, as well as in-store POS materials, such as mini-catalogs for customers, window graphics, videos, and duratrans."

- Kathy Corey, Day's Jewelers
Proudly selling Rembrandt Charms for over 35 years!

Contact us for more info on our Business Building Charm Program!

Orders@RembrandtCharms.com • www.RembrandtCharms.com • p.800-828-7840 • f.800-828-7811



Lifetime Warranty



Handcrafted in USA & Canada



Thousands of Charms in Gold and Silver



Retail Locator



Business Building Charm Program

EXHIBITORS



Reko



Booth 403

333 Washington St #851.
Boston, MA 02108
800-736.0885 Fax: 617-367-2626
www.rekosettings.com

Largest selection of semi-mounts for earrings – pendants – and rings. Choose from over 800 models to set your loose gems and diamonds – customized as needed. Also showcasing extensive selection of gemstone jewelry.

Sam Mulani
sam@rekoinc.com

Rembrandt Charms



Booth 22

370 S Young's Rd
Willamsville, NY 14221
www.rembrandtcharms.com

Only Rembrandt Charms offers thousands of charms in such a wide range of precious metals, including Sterling Silver, Gold Plate, 10K and 14K yellow gold, and 14K white gold.

Megan Ciarfella
Mciarfella@rembrandtcharms.com





SELECT
JEWELRY SHOW

Dallas, TX
Ritz-Carlton Hotel
September 8-9, 2019

ROMAN+JULES™
BY FIRST IMAGE DESIGN

516.498.8282 • sales@romanandjules.com • 98 Cuttermill Rd Suite 231 Great Neck NY 11021

EXHIBITORS



Roma Designs



Booth 304

130 Club Falls Dr
Alpharetta, GA 30022
404-3963500 Fax: 770-343-8039

Roma Designs has been one of the most trusted and widely respected names in the diamond jewelry business for more than 17 years. They offer a dazzling range of exquisitely crafted fine jewelry featuring contemporary fashion forward diamond designs.

Roma Lalwani
romadesigns@msn.com

Roman + Jules

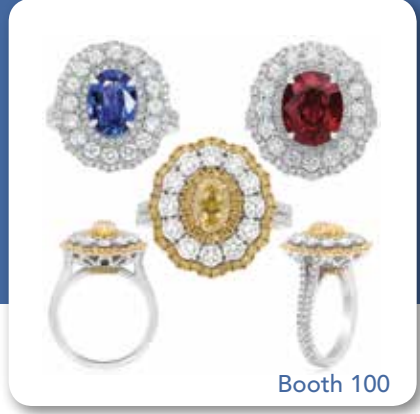

Booth 100

98 Cuttermill Rd #231
Great Neck, NY 11021
516-498-8282 Fax: 516-498-8484
www.romanandjules.com

Roman+Jules defies the traditional with their beautiful and bold Yellow Label diamond designs. Craftsmanship, fashion, and personal expression are the core of this inspired brand; shown through their gorgeous jewelry and spoken through an extraordinary marketing program.

Shawn Hematian
shawn@romanandjules.com



ROMAN+JULES™



COSTAR

FOR YOUR PRECIOUS MOMENTS...



www.costarimports.com

Toll Free: 888.726.7827

Custom CAD Delivered in 2 Weeks!



Available on the
App Store

ANDROID APP ON
Google play

EXHIBITORS



Royal Chain

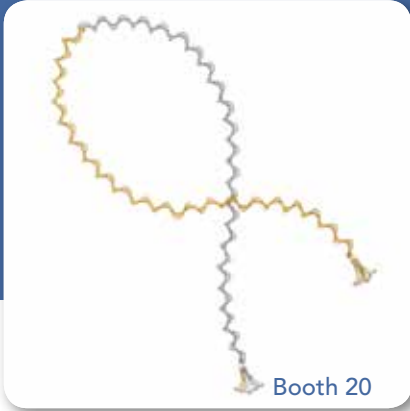

Booth 20

2 West 46th St
New York, NY 10036
212-382-3340 Fax: 212-730-7616
www.royalchain.com

Royal Chain is the industry's leader in gold. Just launched this summer comes their brand new special edition gold collection, featuring updated classics and innovative new gold fashions. Their other areas of expertise include silver, the nationally recognized brand Phillip Gavriel, and other trend products.

Kamran Melamed
kam@royalchain.com

Royal Jewelry/ Diamonds Forever



Booth 31

825 Northern Blvd.
Great Neck, NY 11021
212-302-2500 Fax: 212-768-0601
www.royaljewelry.com

Royal Jewelry has three generations of experience in the gem and jewelry trade. Royal's designs, superb craftsmanship, and astonishing value are known throughout the world. Our line of timeless pieces encompasses classic and fashion-forward designs.

Michael Hakimian
michael@royaljewelry.com



EXHIBITORS

Royal Pearl



Booth 31

17 N. Wabash Ave Ste 420
Chicago, IL 60602
312-236-9228
www.royal-pearl.com

Royal Pearl is a direct importer of Cultured, South Sea and Tahitian pearls. Royal Pearl has blended a visionary design approach with the innovative application of state-of-the-art technology to create a unique high quality collection of jewelry.

Jim Esser
rpc641@aol.com

Alan Gould
Alanjsb@sbcglobal.net

ROYAL PEARL

Samuel B.



Booth 302

98 Cuttermill Rd.
Suite 234 South
Great Neck, NY 11021
855-SamueB
www.Wholesale.SamuelB.com

Samuel Behnam is an award-winning New York based jewelry designer and founder of the Samuel B. Collection. Inspired by the immeasurable beauty of nature and the ancient traditions of Balinese and Thai jewelry craftsmanship, Samuel has made designing stunning jewelry his life's work.

Mathew Behnam
Mathew@SamuelB.com

SAMUEL B.

New York • Bali

Sophia by Design



Booth 303

457 Haddonfield Road, Suite 420
 Cherry Hill, NJ 08002
www.sophiabydesign.com
 215-629-0260

Destination: Style... with over 30 years of dedication to excellence, we are proud to present our 2019 internationally inspired collections. Each design is crafted with sophistication and quality with today's woman in mind. Wherever the journey takes you, arrive in style with Sophia.

Shaul Reznik
sales@sophiabydesign.com



Shefi

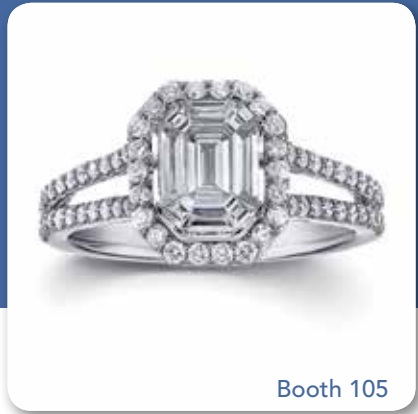

Booth 105

580 Fifth Ave., Ste. 1227
 New York, NY 10036
 212-391-1482
www.shefidiamonds.com

Shefi Diamonds, features our new must-see Bridal Display Program. Shefi provides diamond anniversary bands, bracelets, bangles, solitaires, stud earrings and more - all in free display elements. From basic to exceptional, visit Shefi Diamonds.

Sanjay Hirawat
info@shefidiamonds.com



SR
STEVEN ROYCE

Certified Alexandrite



BOOTH
18
(Dallas)

516-466-0700

WWW.STEVENROYCE.COM EMAIL: INFO@STEVENROYCE.COM



JEWELERS FOR CHILDREN
A GIFT OF LOVE FOR CHILDREN IN NEED

follow us on



Steven Royce Designs



Booth 18

98 Cuttermill Rd. #96
Great Neck, NY 11021
516-466-0700 Fax: 516-466-0720
www.stevenroyce.com

Steven Royce has been manufacturing fine jewelry for over 30 years, specializing in alexandrite, tanzanite, emerald, ruby, and sapphire jewelry.

Jason Rahimi
info@stevenroyce.com

Vivid Jewels



Booth 305

15 W 47th St., Ste 605
New York, NY 10036
212-575-9127 Fax: 212-575-9821

Diamond and pearl jewelry that will take your breath away!

Michael Livi
michaellivi2@gmail.com

**STEVEN ROYCE**

VIVID JEWELS
NEW YORK

EXHIBITORS



William Levine Fine Jewels

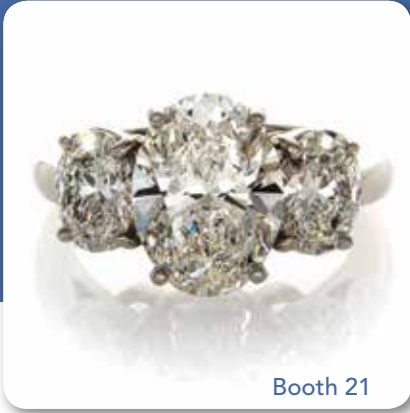

Booth 21

29 E. Madison St., Suite 1414
Chicago, IL 60602
312-236-3700 Fax: 312-580-7470
www.wlfj.com

William Levine strives to create more fabulous yet affordable diamond, precious stone and semi-precious stone pieces. "We have something for everyone" is our approach. From \$800 bangles to \$250,000 diamond necklaces we try to offer our customers a vast array.

David Levine
davidl@wlfj.com



WILLIAM LEVINE
Fine Jewels LLC

Zeghani

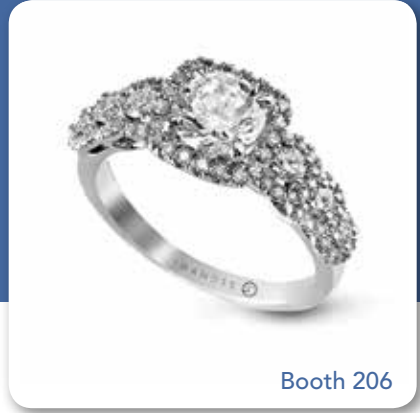

Booth 206

528 State Street
Glendale, CA 91203
818-500-4173
Zeghani.com

My name is Zaven Ghanimian and I am the Co-Founder and CEO of Zeghani. Being raised in a household where artistry was portrayed and encouraged, I grew up aspiring to become a jewelry designer. In 2008, my brother, Co-Founder and Head Designer, Hratch Ghanimian and I established Zeghani in Los Angeles. Our mission in establishing our brand has been to design and create high quality bridal and fashion jewelry in 14K Gold, making them more affordable without compromising the beautiful design or the craftsmanship. What makes Zeghani Jewelry one of a kind is the attention to detail.

Scott Bates
scottb@zeghani.com



Z E G H A N I
LOVE IS IN THE DETAILS



Z E G H A N I

LOVE IS IN THE DETAILS



INVITES YOU TO BOOK AN APPOINTMENT FOR

SELECT JEWELRY SHOW

RSVP with your Zeghani Sales Rep.
Contact Shant Kouladjian at ShantK@zeghani.com

VISIT CEDAR ROOM

SEPTEMBER 8TH & SEPTEMBER 9TH, 10AM TO 6PM

MR16



Jewelry LED

GU10



www.JewelryLED.com

sales@JewelryLED.com | 888-427-8886

Let Us Light Up Your Sales!

**Select Dallas
Booth #407**



Par16



Par30



Par38

Multi-Directional
5 LED Stand

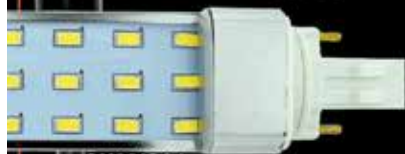

GX23/G24



E12
Chandelier



T8 Tubes (2ft - 5ft)

Call for a free lighting consultation! LED Strips (1ft - 5.5ft)

Lustour
Eternal Fire

www.Lustour.com

sales@AiyaDesigns.com | 888-427-8886

*Lab Created Marvel
that comes
with a Lifetime Warranty!*



HEARTS



ARROWS

Lustour
Premium

**Select Dallas
Booth #407**

- Tests positive as a Diamond on Thermal diamond testers

- Carbon Infused to create similar
properties to a mined diamond

- G-H Color



\$975/ct MSRP

Dollar for Dollar Stock, Balancing Across All Our Lines



We are Jewelers of America.
YOU are Jewelers of America.

Join us.

REPRESENTATION ♦ RESOURCES ♦ RECOGNITION



JEWELERS OF AMERICA

Become a member today!

Join online at www.jewelers.org/join or call (800) 223-0673



Select Tucson 2020

The perfect start to Tucson Gem Week.



Select Jewelry Shows has added Tucson, Arizona to its successful line up. The exciting new Select Tucson event will be held at the luxurious Westin La Paloma Resort in Tucson, AZ on February 2-3, 2020.

Select Tucson will be in keeping with the Select Show formula that works so well. A two-day event, Sunday and Monday featuring a limited number of better manufacturers and designers.

The Select Tucson schedule of Sunday and Monday works perfectly for better retailers coming to town for Tucson's important gem shows. It will transition seamlessly into the kick-off of the major shows that open on the following day, Tuesday, February 4th such as the AGTA

GemFair. It does not interfere or overlap with the main Tucson shows. It provides buyers the opportunity to meet with well-known fine jewelry designers and manufacturers before the other shows for better use of their time.

Select Shows are known for their elegant yet fun and relaxed atmosphere where qualified retailers receive-

- Two complimentary nights at the host hotel
- Delicious breakfast, lunch, and afternoon wine service and hors d'oeuvre both days
- \$10,000 total give away raffles both days (to be spent on the buying floor)
- A fun cocktail party for mingling on Sunday evening



To register email: tucson@SelectJewelryShow.com or call: 844-285-1103



GEM + JEWEL

Gem + Jewel and the Select Show have partnered to introduce an exciting new online jewelry marketplace, designed by a retailer, for retailers.

Gem + Jewel offers independent jewelry retailers turnkey, e-commerce-enabled websites, with no hosting fees.



THE FIRST
25 RETAILERS
TO SIGN UP
WILL RECEIVE A FREE
ECOMMERCE WEBSITE
TO BE LAUNCHED
BY THANKSGIVING.



CONTACT

Mark Smelzer

917.273.0357

mark@gemandjewel.com

or

Shelia Bayes

859.333.1303

shelia@gemandjewel.com

NEW NOW

Jewelry That Makes A Statement Without Saying A Word

DISCOVER MORE





64 W 48th St., Ste 1005
New York, NY 10036

REGISTER TODAY
844-285-1103

www.selectjewelryshow.com

Excellence Redefined